

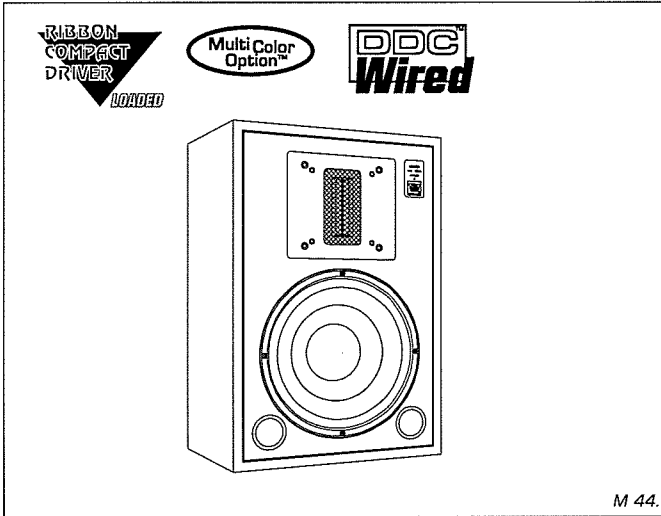

stage accompany

Technical specifications M 44



Master M 44

In this documentation you will find information about:

- Placement
- Connection
- Maintenance
- Active/Passive switch
- Options
- Dynamic Damping Control™
- Recommendation
- Technical specifications

Placement

Optimal positioning of the M 44 can best be done with the expertise of an (Stage Accompany) acoustics engineer. In-wall/flush mounting is recommended.

Connection

The M 44 has two 4-pole Speakon connectors. If you use the M 44 cabinet in 'passive' mode, use the lower connector. If used in 'active' mode, use the upper and lower connector for resp. High/Low (Caution: Incorrect connection when used in 'active' mode can cause damage to the loudspeaker components).

Maintenance

Maintenance on the M 44, especially on the drivers and filtering is best left to official Stage Accompany service personnel. However, cleaning of the housing can easily be done by yourself with a damp, non fluffing cloth.

Active/Passive switch

Factory setting is passive (single amp) filtering. Changing the M 44 from 'passive' to 'active' mode is best left to official Stage Accompany service personell. If you want to do this yourself it is required to remove the woofer from the cabinet and put the active/passive socket in the right place, ask your Stage Accompany dealer for information.

Options

The M 44 is standard finished in opal white finish, other (metallic) colors are available on request. Further options are: - Flight-case
- Small Uni-Rig™ flying system

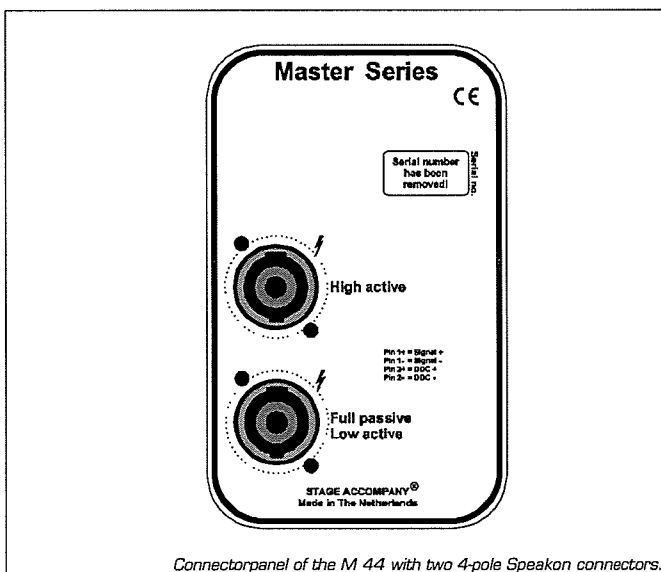

Connectorpanel of the M 44 with two 4-pole Speakon connectors.

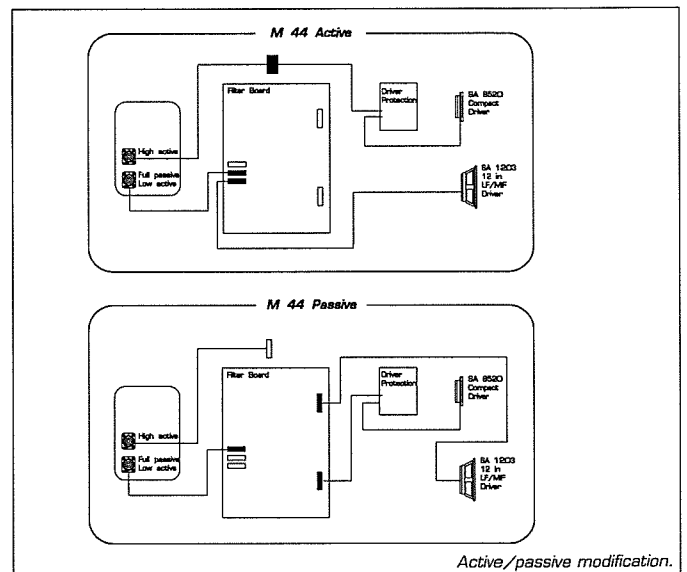

Active/passive modification.

Dynamic Damping Control DDC™

For absolute top quality sound reproduction, the M 44 is completely pre wired for Dynamic Damping Control™. The DDC™ system is based on 2 loudspeaker wires that return from the speaker to the (SA) amplifier. Through these "sense wires" the amplifier can compensate the speaker cable and connector resistance, ensuring maximum control over the speaker cone movement.

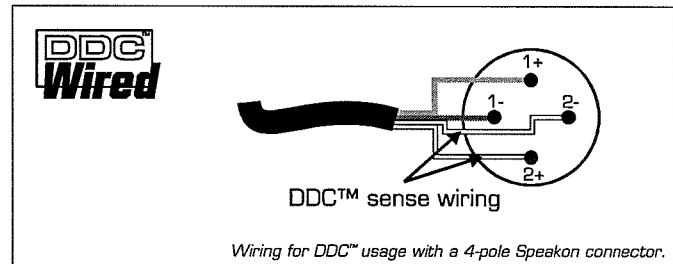

Recommendation

To use the M 44(S) we recommend the PPA 1200 programmable power amplifier. This amplifier is standard equipped with DDC™, resulting in a virtually infinite amplifier damping factor at the speaker terminals. For best possible function of the DDC™ system, use Stage Accompany 4-pole LW Speakon cable [Caution! to avoid damage to your cabinets; do not use the M 44 programmed PPA 1200 with cabinets other than the M 44.

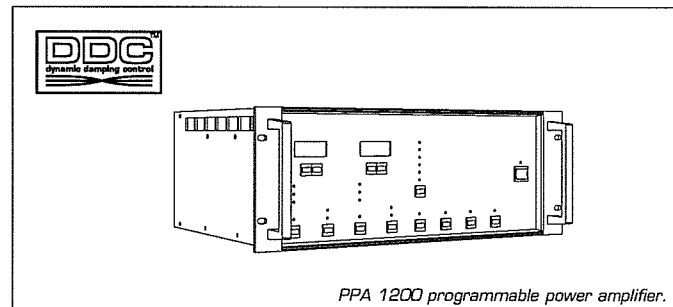

Technical specifications

	Passive mode	Active mode
Frequency response	: 45 Hz - 30 kHz (+/- 3dB)	
Drivers	: 1 x SA 1203 LF driver; 1 x SA 8520 HF driver	
Cross-over frequency	: 1000 Hz	
Nominal impedance	: 8 Ω	8 Ω (LF) 13 Ω (HF)
Sensitivity @ 1W/1m	: 93 dB	93 dB (LF) 93 dB (HF)
Max. RMS power	: 400 W	400 W (LF) 30 W (HF)
Max. Peak power	: 1000 W	1000 W (LF) 500 W (HF)
SPL program/peak (dB)	: 119/123	119/123 (LF), 108/120 (HF)
Dispersion (2 kHz H x V)	: 100° x 40°	
Color	: Opal white finish, other colors on request	
Connectors	: 2 x 4 pole Speakons; 1 x High active, 1 x Full passive/low active	
Physical dimensions (h x w x d)	: 612 x 406 x 320 mm (24.1 x 16.0 x 12.6 in.)	
Weight	: 43 kg (94,6 lb)	

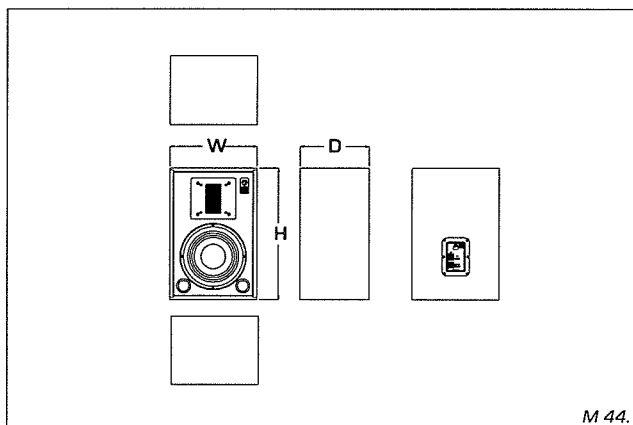

Stage Accompany
Anodeweg 4
1627 LJ HOORN
The Netherlands
Tel: +31 (0)229 282930
Fax: +31 (0)229 282920
E-mail: info@StageAccompany.com

© Copyright 1999 Stage Accompany.

The information in this document is continually being developed. Whilst every effort has been made to make it as accurate as possible, no warranty of accuracy is made or implied by the makers. Stage Accompany shall have neither liability, nor responsibility to any person or entity with respect to loss or damages in connection with or arising from the information contained in this document.

www.StageAccompany.com

A NEW WORLD OF SOUND!®

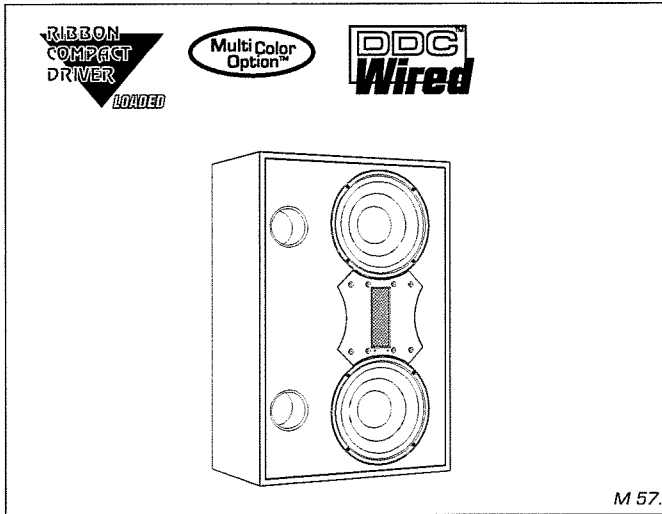

Placement

Optimal positioning of the M 57 can best be done with the expertise of an (Stage Accompany) acoustics engineer. In-wall/flush mounting is recommended. Note: the M 57 cabinets are made per pair so the loudspeaker placement is mirrored.

Connection

The M 57 has two 4-pole Speakon connectors. If you use the M 57 cabinet in 'passive' mode, read the mentions below the connectors. If used in 'active' mode, read the mentions above the connectors (Caution: Incorrect connection when used in 'active' mode can cause damage to the loudspeaker components).

Master M 57

In this documentation you will find information about:

- Placement
- Connection
- Maintenance
- Active/Passive switch
- Options
- Dynamic Damping Control™
- Recommendation
- Technical specifications

Maintenance

Maintenance on the M 57, especially on the drivers and filters is best left to official Stage Accompany service personnel. However, cleaning of the housing can easily be done by yourself with a damp, non fluffing cloth.

Active / Passive switch

The 'active / passive' switches are located on the connector-panel of the M 57 cabinet (Caution: Never switch to another mode when the cabinet is in use! In order to avoid impedance problems, be sure that both switches always point in the same direction).

Options

The M 57 is standard finished in opal white finish, other (metallic) colors are available on request. Further options are:

- Flight-case
- Small Uni-Rig™ flying system

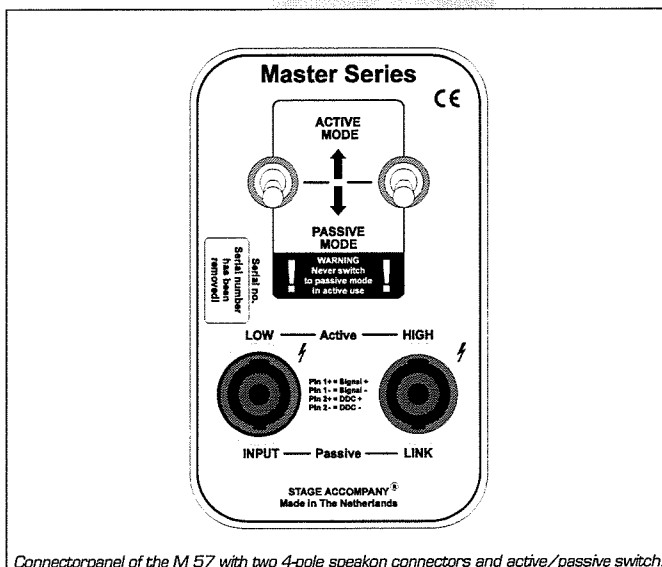

Connectorpanel of the M 57 with two 4-pole speakon connectors and active/passive switch.

Dynamic Damping Control DDC™

For absolute top quality sound reproduction, the M 57 is completely pre wired for Dynamic Damping Control™. The DDC™ system is based on 2 loudspeaker wires that return from the speaker to the (SA) amplifier. Through these "sense wires" the amplifier can compensate the speaker cable and connector resistance, ensuring maximum control over the speaker cone movement.

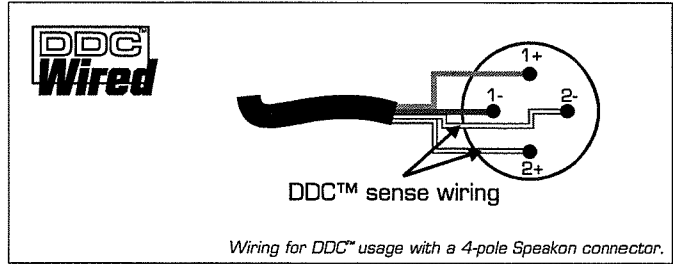

Recommendation

To use the M 57 we recommend the PPA 1200 programmable power amplifier. This amplifier is standard equipped with DDC™, resulting in a virtually infinite amplifier damping factor at the speaker terminals. For best possible function of the DDC™ system, use Stage Accompany 4-pole LW Speakon cable (Caution! to avoid damage to your cabinets; do not use the M 57 programmed PPA 1200 with cabinets other than the M 57.

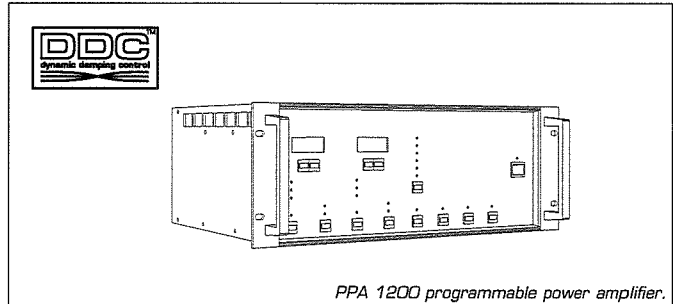

Technical specifications

Passive mode

Active mode

Frequency response	: 35 Hz - 20 kHz (+/- 3dB)	
Drivers	: 1 x SA 1205 LF driver; 1 x SA 8535M HF driver	
Cross-over frequency	: 1500 Hz	
Nominal impedance	: 16 Ω	4 Ω (LF) 13 Ω (HF)
Sensitivity @ 1W/1m	: 97 dB	97 dB (LF) 102 dB (HF)
Max. RMS power	: 800 W	800 W (LF) 60 W (HF)
Max. Peak power	: 2000 W	8000 W (LF) 2000 W (HF)
SPL program/peak (dB)	: 126/130	126/130 (LF), 120/132 (HF)
Dispersion (2 kHz H x V)	: 100° x 40°	
Color	: Opal white finish, other colors on request	
Connectors	: 2 x 4 pole Speakons; 1 x Input, 1 x Link	
Physical dimensions (h x w x d)	: 908 x 540 x 435 mm (35.7 x 21.3 x 17.1 in.)	
Weight	: 74 kg (162.8 lb)	

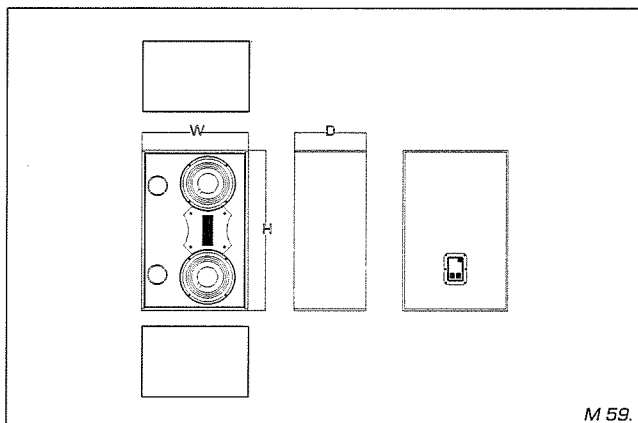

Stage Accompany
 Anodeweg 4
 1627 LJ HOORN
 The Netherlands
 Tel: +31 (0)229 282930
 Fax: +31 (0)229 282920
 E-mail: info@StageAccompany.com

© Copyright 1999 Stage Accompany.

The information in this document is continually being developed. Whilst every effort has been made to make it as accurate as possible, no warranty of accuracy is made or implied by the makers. Stage Accompany shall have neither liability, nor responsibility to any person or entity with respect to loss or damages in connection with or arising from the information contained in this document.

www.StageAccompany.com

A NEW WORLD OF SOUND!®



stage accompany

Technical specifications M 59

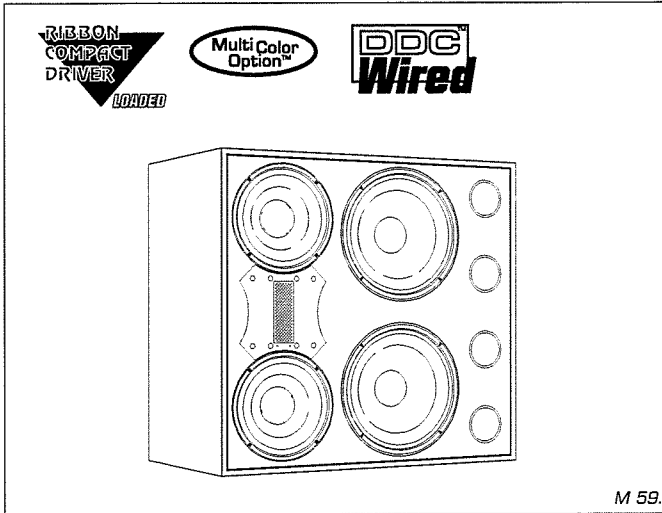

Master M 59

In this documentation you will find information about:

- Placement
- Connection
- Maintenance
- Options
- Dynamic Damping Control™
- Recommendation
- Technical specifications

Placement

Optimal positioning of the M 59 can best be done with the expertise of an (Stage Accompany) acoustics engineer. In-wall/flush mounting is recommended. Note: the M 59 cabinets are made per pair so the loudspeaker placement is mirrored.

Connection

The M 59 has three 4-pole Speakon connectors. Since the cabinet is designed for active use you will find connectors for: low, mid and high (caution: make sure that the right amplifier output is connected to the right connector in order not to damage any of the loudspeaker components).

Maintenance

Maintenance on the M 59, especially on the drivers is best left to official Stage Accompany service personnel. However, cleaning of the housing can easily be done by yourself with a damp, non fluffing cloth.

Options

The M 59 is standard finished in opal white finish, other (metallic) colors are available on request. Further options are: - Flight-case
- Small Uni-Rig™ flying system

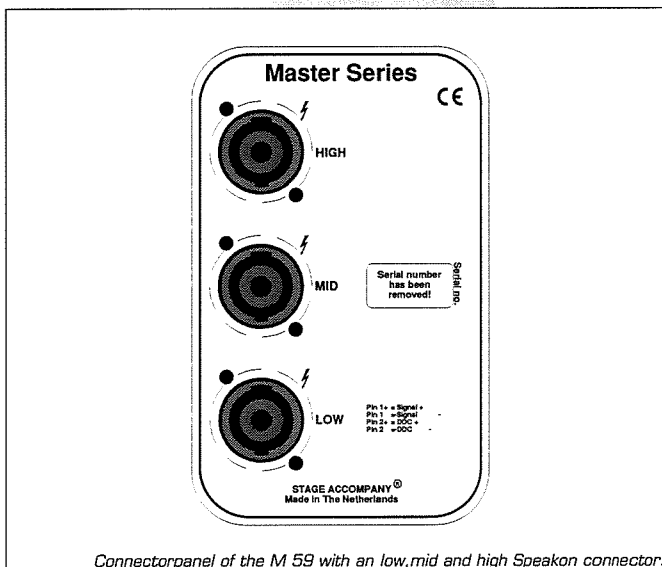

Connectorpanel of the M 59 with an low, mid and high Speakon connector.

Dynamic Damping Control DDC™

For absolute top quality sound reproduction, the M 59 is completely pre wired for Dynamic Damping Control™. The DDC™ system is based on 2 loudspeaker wires that return from the speaker to the (SA) amplifier. Through these "sense wires" the amplifier can compensate the speaker cable and connector resistance, ensuring maximum control over the speaker cone movement.

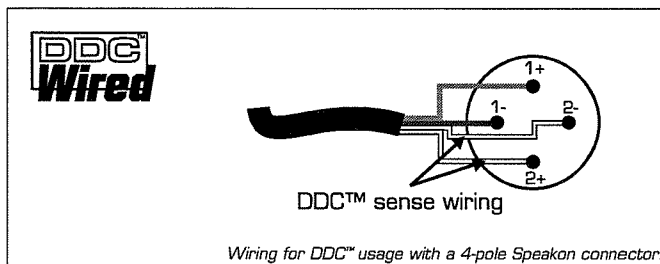

Recommendation

To use the M 59 we recommend the PPA 1200 programmable power amplifier. This amplifier is standard equipped with DDC™, resulting in a virtually infinite amplifier damping factor at the speaker terminals. For best possible function of the DDC™ system, use Stage Accompany 4-pole LW Speakon cable (Caution! to avoid damage to your cabinets; do not use the M 59 programmed PPA 1200 with cabinets other than the M 59).

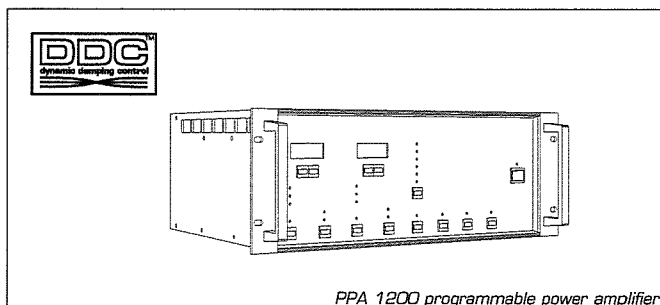

Technical specifications

Frequency response	: 35 Hz - 30 kHz (+/- 3dB)
Drivers	: 2 x SA 1513 LF/MF driver 2 x SA 1203 MF driver 1 x SA 8535M HF driver
Cross-over frequency	: 1400 Hz
Nominal impedance	: 4 Ω (LF), 4 Ω (MF), 13 Ω (HF)
Sensitivity @ 1W/1m	: 98 dB (LF), 98 dB (MF), 102 dB (HF)
Max. RMS power	: 800 W (LF), 800 W (MF), 60 W (HF)
Max. Peak power	: 2000 W (LF), 2000 W (MF), 1000 W (HF)
SPL program/peak (dB)	: 127/131 (LF), 127/131 (MF), 120/132 (HF)
Dispersion (2 kHz H x V)	: 100° x 40°
Color	: Opal white finish, other colors on request
Connectors	: 3 x 4 pole Speakon; 1 x Low, 1 x Mid, 1 x High
Physical dimensions (h x w x d)	: 908 x 965 x 569 mm (35.8 x 38.0 x 22.4 in.)
Weight	: 157 kg (345 lb)

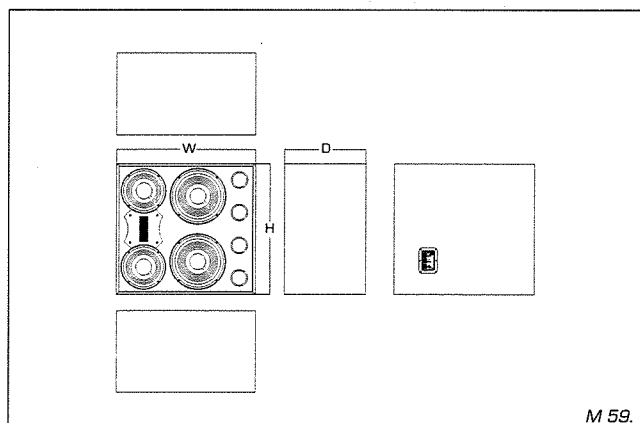

Stage Accompany
Anodeweg 4
1627 LJ HOORN
The Netherlands
Tel: +31 (0)229 282930
Fax: +31 (0)229 282920
E-mail: info@StageAccompany.com

© Copyright 1999 Stage Accompany.

The information in this document is continually being developed. Whilst every effort has been made to make it as accurate as possible, no warranty of accuracy is made or implied by the makers. Stage Accompany shall have neither liability, nor responsibility to any person or entity with respect to loss or damages in connection with or arising from the information contained in this document.

www.StageAccompany.com

A NEW WORLD OF SOUND!®



stage accompany

Technical specifications PS 44

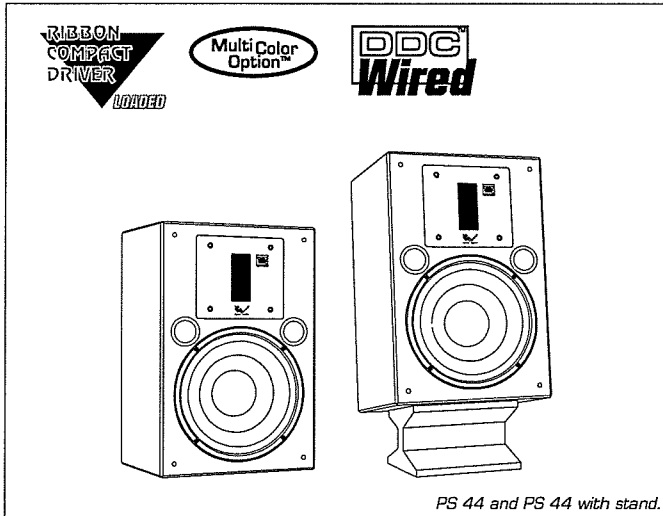

PS 44 and PS 44 with stand.

Stage Accompany is a renowned Dutch manufacturer of loudspeaker systems for 20 years running, specialized in the development and production of high-quality professional sound systems used in theaters, cinemas and studios a.o.

Digital techniques have already entered all these markets. Since the digital evolution has not yet come to an end, the demands on the equipment become higher and higher, on both digital and analogue reproduction. The loudspeaker is still the biggest limitation in the reproduction chain.

Studio quality

Through many years of development and production, Stage Accompany sound systems offer an unequalled sound quality. This expertise has now been applied to make professional [studio] quality accessible to the 'home studio'. As a result of the demand of many professional sound technicians, who wanted the Stage Accompany sound quality at home, Stage Accompany developed the Personal PS 44 series.

The Personal PS 44 is directly derived from the Master Series studio monitors, as these are used in many renowned recording studios all over the world, and are developed to approach the 'Single-point source' theory as good as possible to guarantee a perfect and neutral reproduction.

Hand crafted

The PS 44 is handcrafted and produced on order. Only this way the PS 44 can meet Stage Accompany's stringent quality demands. Therefore all components are manufactured and developed 'in house'. Thanks to the extremely low production tolerances and thorough quality checks, it is possible for Stage Accompany to guarantee the high quality of her products.

Personal PS 44

- Studio quality
- Handcrafted
- SA 8520 Ribbon Compact Driver™
- Equal World™ design
- Available in any color

SA 8520 Ribbon Compact Driver™

The PS 44 Personal monitor is a 2-way design, equipped with the unique Stage Accompany 8520 Ribbon Compact Driver™. With this mid/high reproducer the voice coil and the diaphragm are integrated. This is a much simpler principle that produces enormous weight savings. Thanks to these characteristics this loudspeakers distinguishes itself in performance; 1.000 Hz up to 30.000 Hz and beyond, a virtually unequalled transient response!

In order to equal the extraordinary qualities of the Ribbon Compact Driver™, Stage Accompany has developed the SA 1203 transducer. This is a 12 inch (30 cm) loudspeaker with a very high warmth-convey in order to give the speaker a constant frequency response at all loads, at all times.

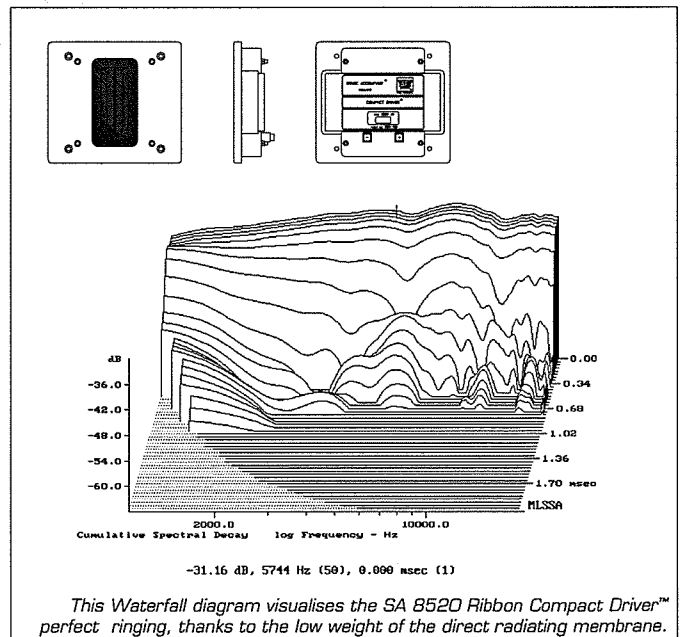

Top quality components

Even at the crossover a minimum of sole top quality components is used to prevent loss, and therefore the signal is kept as pure as possible. Connection is done with a Speakon connector; all is aimed at a reliable and precise reproduction. This top-quality reproduction coupled to the high load of the loudspeaker components results in enormous headroom at all loads. Thanks to the high sensitivity and stable impedance, the PS 44 can be connected to any (quality) amplifier!

Equal World™ design

The housing is finished in the 'Equal World™' design, which characterizes itself by low profile design with feeling for understatement. The PS 44 is available in any demanded color or finish. The styling of the Personal will blend into any interior. The supplied frontcover is finished with acoustic transparent cloth. An optional stand places the Personal in the best listening angle and height.

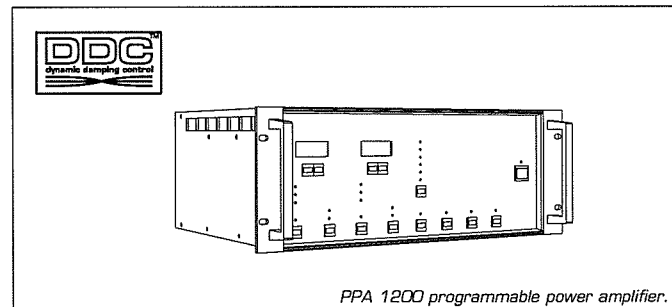
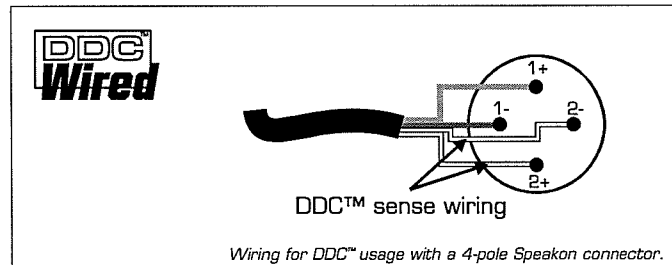

Technical specifications

Frequency response	: 45 Hz - 30 kHz (+/- 3dB)
Drivers	: 1 x SA 1203 LF driver; 1 x SA 8520 MF/HF Driver
Cross-over frequency	: 1000 Hz
Nominal impedance	: 8 Ω
Sensitivity @ 1W/1m	: 93 dB
Max. RMS power	: 400 W
Max. Peak power	: 1000 W
SPL program/peak [dB]	: 119/123
Dispersion (2 kHz H x V)	: 100° x 40°
Color	: Anthracite, other colors on request
Connectors	: 1 x Silver plated 4 pole Speakon; 1 x Input
Physical dimensions (h x w x d)	: 575 x 370 x 375 mm (22.6 x 14.6 x 14.8 in.)
Weight	: 34 kg (74,5 lb)
Options	: Metallic finish; 30 cm stand (same color); marble finish

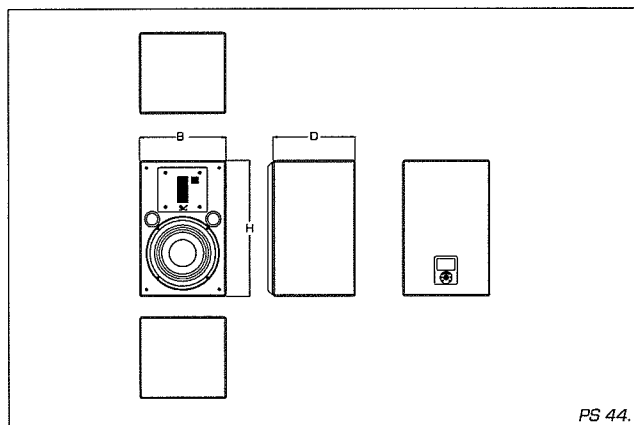

SA
stage accompany

Stage Company
Anodeweg 4
1627 LJ HOORN
The Netherlands
Tel: +31 (0)229 282930
Fax: + 31 (0)229 282920
E-mail: info@StageAccompany.com

© Copyright 1999 Stage Company.

The information in this document is continually being developed. Whilst every effort has been made to make it as accurate as possible, no warranty of accuracy is made or implied by the makers. Stage Company shall have neither liability, nor responsibility to any person or entity with respect to loss or damages in connection with or arising from the information contained in this document.

www.StageAccompany.com

A NEW WORLD OF SOUND!®